

EDGE-O-DOCKLEVELER - PE-2078

APPROX WEIGHT: 558.18 lbs.
 DOES NOT INCLUDE WEIGHT OF POWER OR PACKAGING!!!

*** ANY ADDITIONS, DELETIONS, OR OMISSIONS MUST BE CORRECTED ON THIS DRAWING AS THIS DRAWING WILL BE CONSIDERED ALL INCLUSIVE ***

ALL GRAPHICS PROVIDED ARE FOR REFERENCE ONLY. IF CERTAIN DIMENSIONS ARE CRITICAL PLEASE VERIFY THOSE DIMENSIONS WITH YOUR SALESPERSON

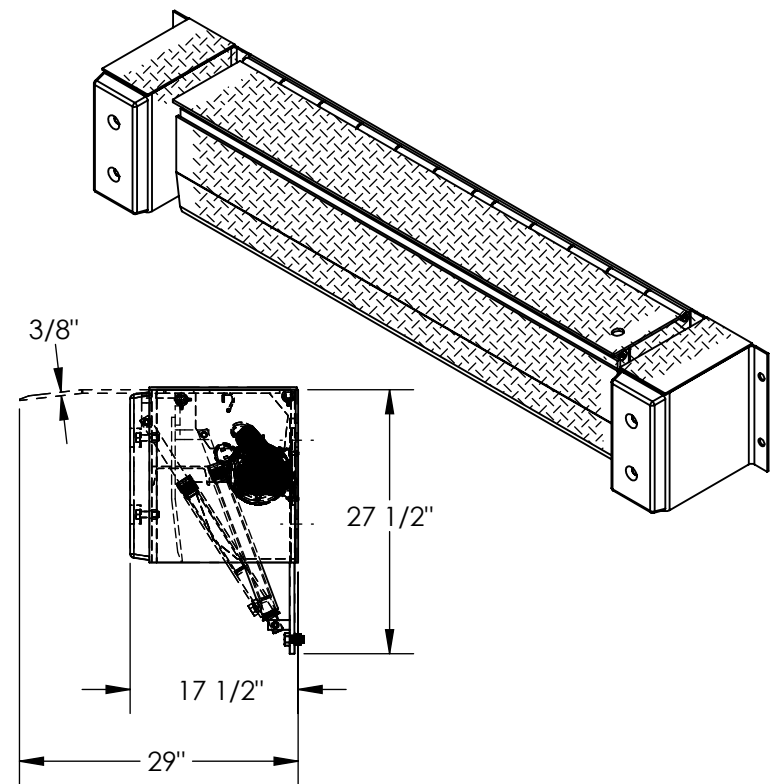
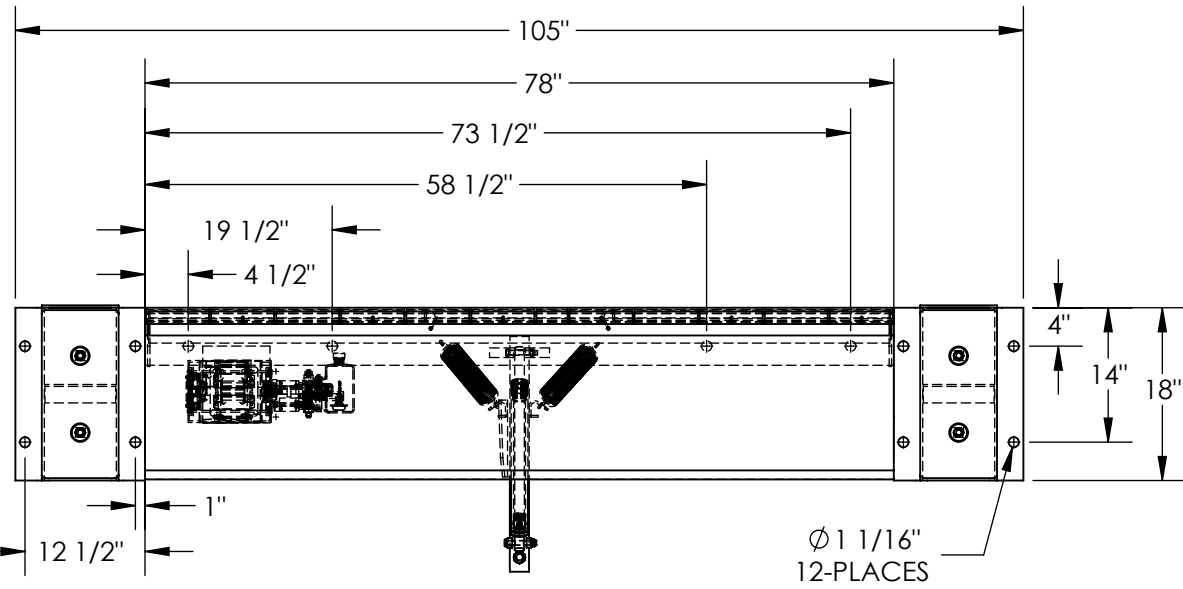

DIMENSION TOLERANCE ± 1/4"

STANDARD FEATURES

- MODEL NUMBER IS PE-2078
- OVERALL WIDTH IS 99"
- DECK WIDTH IS 72"
- OVERALL DEPTH WITH RAMP OUT IS 29"
- BUMPER PROJECTION IS 17 1/2"
- UNIFORM CAPACITY IS 20,000 lbs.
- 5" ABOVE / 5" BELOW SERVICE RANGE
- RECOMMENDED FOR DOCKS AT LEAST 48" HIGH.
- UNIT COMES WITH MOTOR, PUMP, CONTROL BOX, CYLINDER, HYDRAULIC LINES AND OIL.
- TREADPLATE RAMP & DECK CONSTRUCTION
- DURABLE LIQUID PAINT BROWN FINISH

SPECIAL FEATURES

NONE

PLEASE CIRCLE SPECIFICATIONS:

POWER	AC	HAND PUMP		
MOTOR VOLTAGE	115	208	230	460
DEDICATED CIRCUIT REQUIRED				
MOTOR PHASE	SINGLE	THREE		
CONTROL	HAND	* FOOT		

* AVAILABLE AT ADDITIONAL COST

APPROVAL

I, THE UNDERSIGNED, AGREE THAT THE PRODUCT AS REPRESENTED SATISFIES DESIGN AND DIMENSION REQUIREMENTS. I ALSO ACKNOWLEDGE MY DUTY TO CONFIRM PRODUCT AND INSTALLATION COMPLIANCE WITH ALL APPLICABLE FEDERAL, STATE AND LOCAL REGULATIONS AND STANDARDS.

UNITS REQUIRING APPROVAL DRAWINGS OR MODIFIED ARE NON-RETURNABLE

[] As drawn [] As marked

Signed: _____ Date: _____

Printed Name: _____

LEAD TIME WILL START UPON RECEIPT OF SIGNED APPROVAL DRAWING

DISTRIBUTOR'S NAME:		P.O.#
VESTIL MANUFACTURING		X
DRAWN BY: TJM		W.O.#
DATE: 09/15/2020		X
REFERENCE: X	SCALE: 1:20	SALES: X
QUOTED LEAD TIME: X	QUOTE #	FILE NAME:
	X	06-007-076